

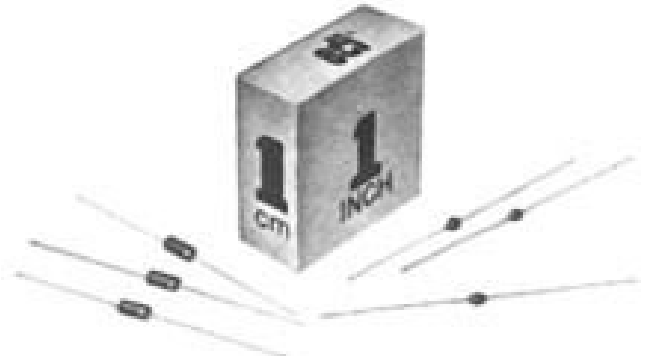

HV HX

**HIGH VOLTAGE RECTIFIERS
ULTRA-MINIATURE
AND MINIATURE**



- SMALL SIZE EPOXY PACKAGES
- FAST AND STANDARD RECOVERY TIMES
- PRV TO 10,000 VOLTS
- VERY LOW REVERSE LEAKAGE

EDI Type No	Peak Reverse Voltage PRV (Volts)	Avg. Forward Current IO (mA) 100°C	Max. Fwd Voltage @ 10mA & 25°C	Max. Peak Surge Current, IFSM (8.3 ms) (Amps)	Package Style
-------------	----------------------------------	------------------------------------	--------------------------------	---	---------------

ULTRA-MINIATURE, STANDARD RECOVERY

EDI Type No	Peak Reverse Voltage PRV (Volts)	Avg. Forward Current IO (mA) 100°C	Max. Fwd Voltage @ 10mA & 25°C	Max. Peak Surge Current, IFSM (8.3 ms) (Amps)	Package Style
HV 15 PD	1,500	80	6.0	5	P
HV 20 PD	2,000				
HV 25 PD	2,500				
HV 30 PD	3,000				
HV 10 P	1,000	50	6.0	5	P
HV 20 P	2,000				
HV 30 P	3,000				
HV 40 P	4,000				
HV 50 P	5,000				

ULTRA-MINIATURE, 100 NANOSECOND RECOVERY (FIG.4)

EDI Type No	Peak Reverse Voltage PRV (Volts)	Avg. Forward Current IO (mA) 100°C	Max. Fwd Voltage @ 10mA & 25°C	Max. Peak Surge Current, IFSM (8.3 ms) (Amps)	Package Style
HX 15 PD	1,500	60	6.0	3	P
HX 20 PD	2,000				
HX 25 PD	2,500				
HX 30 PD	3,000				
HX 10 P	1,000	40	10.0	3	P
HX 20 P	2,000				
HX 30 P	3,000				
HX 40 P	4,000				
HX 50 P	5,000				

MINIATURE, 100 NANOSECOND RECOVERY (FIG.4)

EDI Type No	Peak Reverse Voltage PRV (Volts)	Avg. Forward Current IO (mA) 100°C	Max. Fwd Voltage @ 10mA & 25°C	Max. Peak Surge Current, IFSM (8.3 ms) (Amps)	Package Style
HX 10 M	1,000	40	10.0	3	M
HX 20 M	2,000				
HX 30 M	3,000				
HX 40 M	4,000				
HX 50 M	5,000				
HX 60 ML	6,000	20	20.0	3	M
HX 80 ML	8,000				
HX 100 ML	10,000				

EDI reserves the right to change these specifications at any time without notice.

HV HX

ELECTRICAL CHARACTERISTICS(at $T_A=25^{\circ}\text{C}$ Unless Otherwise Specified)

	HV Series	HX Series
Max. DC Reverse Current @ PRV and 25°C , I_R	10nA	100nA
Max. DC Reverse Current @ PRV and 100°C , I_R	$3\mu\text{A}$	$5\mu\text{A}$
Ambient Operating Temperature Range, T_A	-55 to $+125^{\circ}\text{C}$	
Storage Temperature Range, T_{STG}	-55 to $+150^{\circ}\text{C}$	

FIG.1

OUTPUT CURRENT vs AMBIENT TEMPERATURE

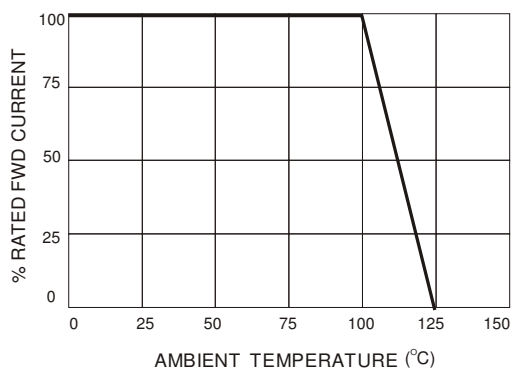

FIG.2

NON-REPETITIVE SURGE CURRENT

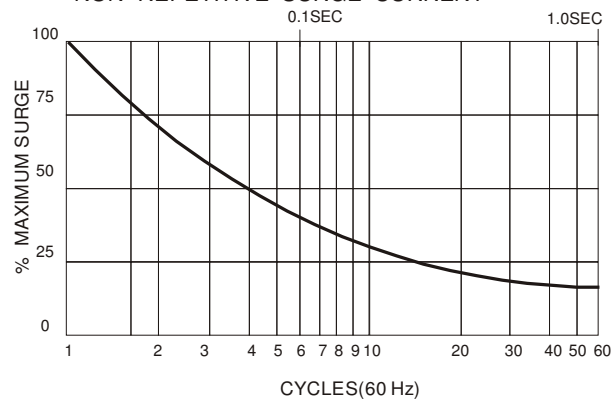

FIG3

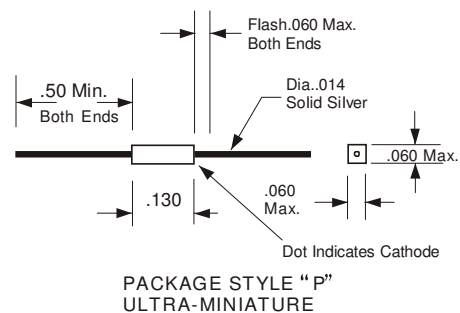
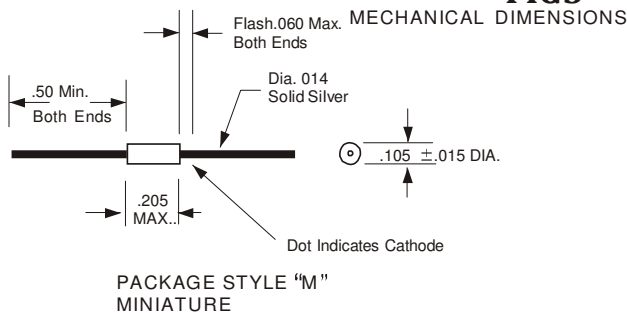
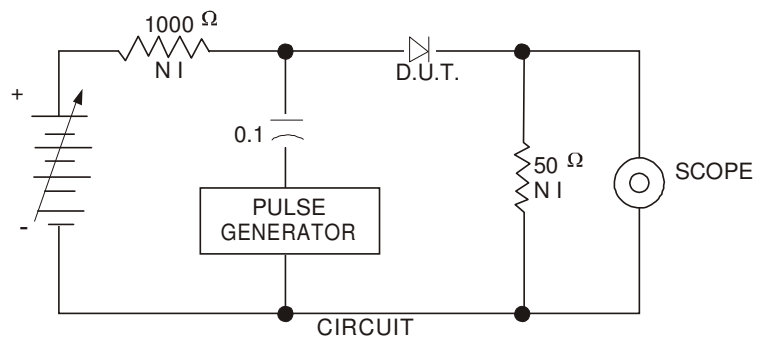
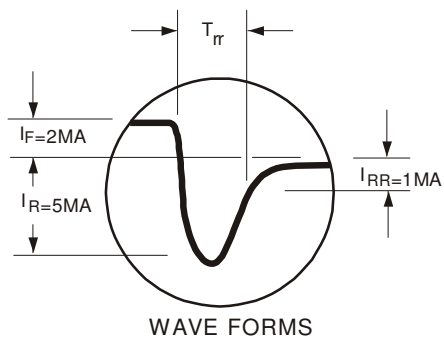

FIG.4

REVERSE RECOVERY TEST METHOD



ELECTRONIC DEVICES, INC. DESIGNERS AND MANUFACTURERS OF SOLID STATE DEVICES SINCE 1951.

21 GRAY OAKS AVENUE * YONKERS * NEW YORK * 10710 * 914-965-4400 * 914-965-5531 (Fax) * 1-800-678-0828

e-mail: sales@ediododes.com * website: <http://www.ediododes.com>